

Bracket 30/30



- Profile finishing: not required





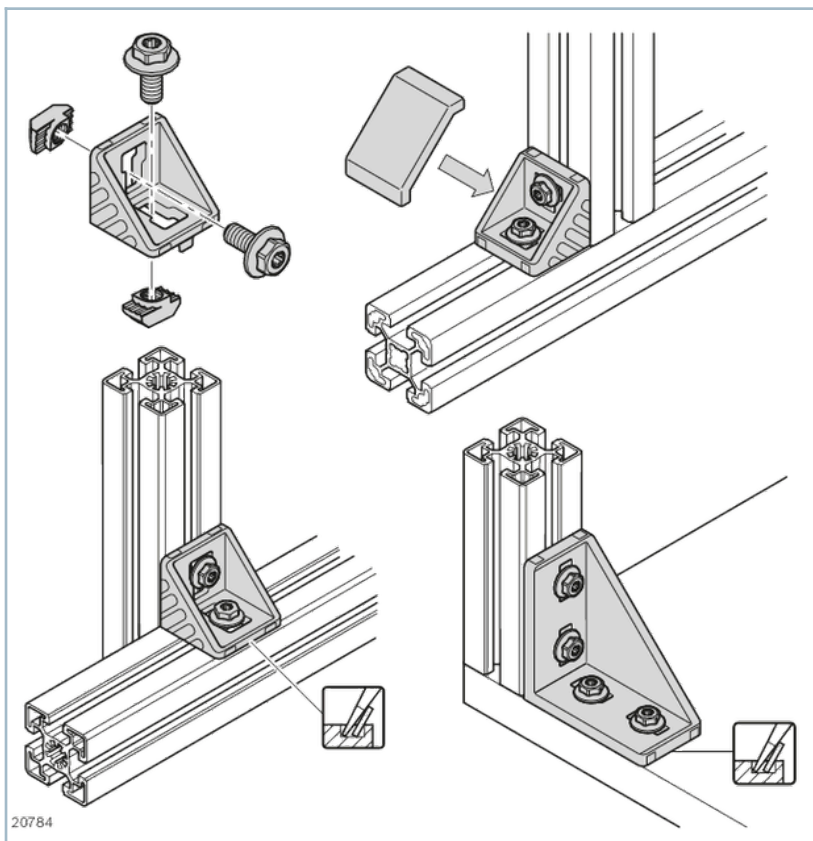
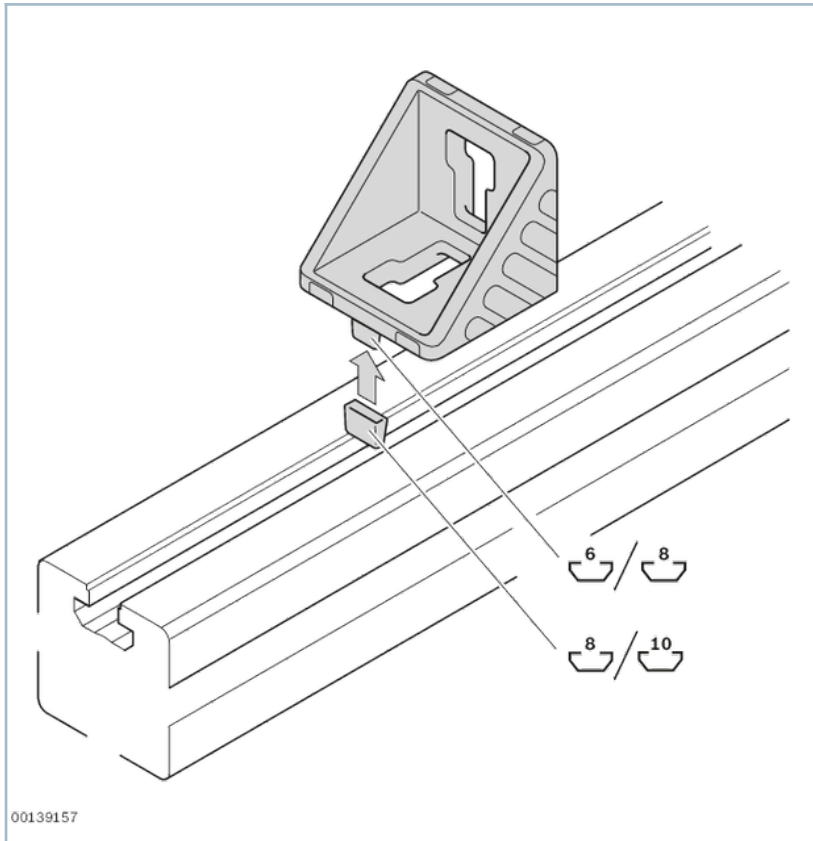



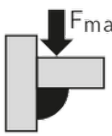
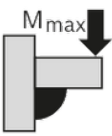

- Brackets with centering lugs for rapid, precise assembly with protection against turning
- Centering lugs can be easily broken off for assembly on plates or at right angles to the slot
- Version *designLINE* with special silver paint (RAL 9006) for an especially high-quality design
- Intermediate element for positioning brackets in the next largest slot
- Cover cap to protect from dirt, available in signal gray (RAL 7004) and black ESD (RAL 9005)



Product description



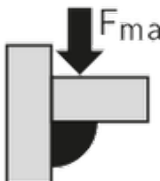
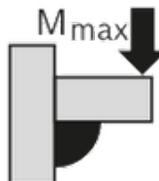
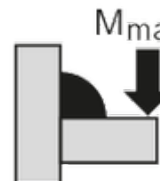

Connection elements, selection criteria

Technical data

	Groove	E S D	Material entry			
				F_{max}	M_{max}	M_{max}
				N	Nm	Nm
Bracket	8		Bracket: Diecast aluminum, vibratory ground Fastening material: steel; galvanized	1250	25	75
	8; 10		Bracket: Diecast aluminum, vibratory ground Fastening material: steel; galvanized	1250	25	75
	10		Bracket: Diecast aluminum, vibratory ground Fastening material: steel; galvanized	1250	25	75
	8		Bracket <i>designLINE</i> : Diecast aluminum; vibratory ground, painted (RAL 9006) Fastening material: steel; galvanized	1250	25	75
	8; 10		Bracket <i>designLINE</i> : Diecast aluminum; vibratory ground, painted (RAL 9006) Fastening material: steel; galvanized	1250	25	75
	10		Bracket <i>designLINE</i> : Diecast aluminum; vibratory ground, painted (RAL 9006) Fastening material: steel; galvanized	1250	25	75
	8		Bracket: Diecast aluminum, vibratory ground	1250	25	75
Cover cap for bracket			PP			
			PP			
Intermediate element for 10 mm slot	8; 10		PA; black			

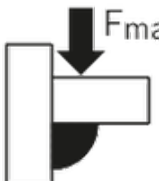
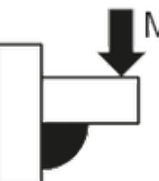
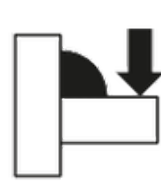
Typ				
30 / 30	1250 N	25 Nm	75 Nm	-

Type				
------	---	---	--	---

30/30	1250 N	25 Nm	75 Nm	-
-------	--------	-------	-------	---

Dimensions

Bracket 30/30 with cover cap

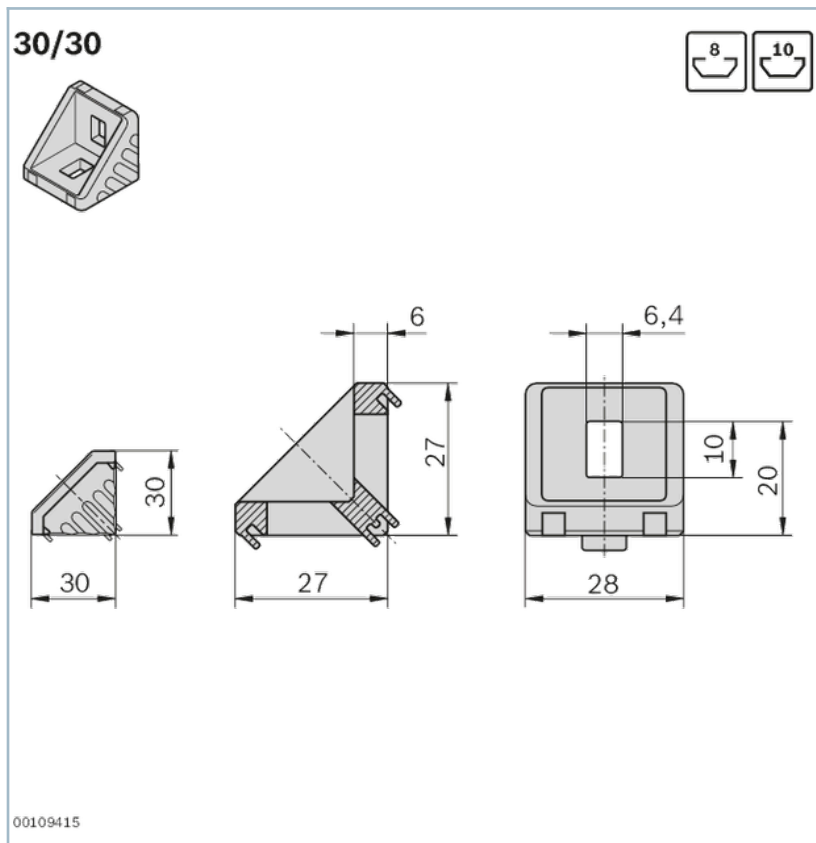

Accessories

Recommended accessories

Intermediate element for 10 mm slot

Cover cap for bracket 30/30, signal gray







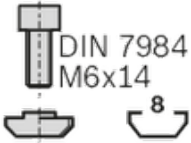
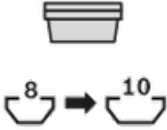
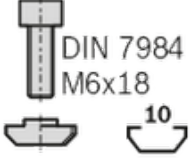

Cover cap for bracket 30/30, black

Intermediate element for 10 mm slot

Delivery notes

FS2	FS3	FS4
 <p>DIN 7984 M6x14</p>		 <p>DIN 7984 M6x18</p>

Ordering codes

	Groove	ESD	FS	No.
Bracket 30x30 set (standard) N8/8	8		2xFS2	3842523528
Bracket 30x30 set (standard) N8/10	8; 10		1xFS2, 2xFS3, 1xFS4	3842523530
Bracket 30x30 set (standard) N10/10	10		4xFS3, 2xFS4	3842523532
Bracket 30x30 set design <i>LINE</i> , N8/8	8		2xFS2	3842551598
Bracket 30x30 set design <i>LINE</i> , N8/10	8; 10		1xFS2, 2xFS3, 1xFS4	3842551600
Bracket 30x30 set design <i>LINE</i> , N10/10	10		4xFS3, 2xFS4	3842551599
Bracket (standard) 30x30	8			3842523525
Cover cap for bracket 30/30, signal gray				3842548846
Cover cap for bracket 30/30, black				3842548847
Intermediate element for 10 mm slot	8; 10			3842523537