

Profile · Profiles · Profilés

Strebenprofile mit 10er-Nut

Strut profiles with 10 mm groove

Profilés d'étayage à rainure de 10 mm

Die neuen Profilbaureihen mit den Rastermaßen 40 mm und 50 mm ergänzen die Profile im 45-Millimeter-Raster konsequent. Der erweiterte Profilbaukasten der Bosch Rexroth AG deckt nun alle auf dem Weltmarkt gängigen Profilraster ab.

Die Strebenprofile ...L mit 10er-Nut (Rastermaße 40 mm, 45 mm und 50 mm, z.B. 50x50L) bieten dank computeroptimierter Konstruktion hohe Festigkeitswerte bei geringem Materialeinsatz. Damit steht Ihnen eine kostengünstige und stabile Lösung zur Verfügung, wenn Sie z.B. Tische, Schutzeinrichtungen oder Gestelle konstruieren.

Für Einsatzfälle mit hohen Belastungen empfehlen wir Profile mit der besonders stabilen 10er-Nut, z. B. für schwere Arbeitstische, Vorrichtungen, Maschinen-gestelle, Transportwagen, Schutzkabinen und Handhabungssysteme. Aufgrund der besonders kräftigen konstruktiven Ausführung ermöglicht diese Nut Verbindungen von höchster Festigkeit.

The new profile product ranges with the modular dimensions of 40 mm and 50 mm logically supplement the profiles of 45 mm in dimension. The extended Bosch Rexroth AG modular profile assembly system now covers all conventional profile dimensions on the world market.

Thanks to their computer-optimized construction the strut profiles L with 10 mm groove (modular dimensions 40 mm, 45 mm and 50 mm, e.g. 50x50L) provide high strengths using a minimum of material. Thus a cost-effective and stable solution is available to you, if you are constructing tables, protective enclosures or frames, for instance.

For applications with high loads we recommend profiles with the particularly robust 10 mm groove, e.g. for heavy worktables, appliances, machine frames, transport shuttles, protective enclosures and handling systems. Due to its very sturdy design, this groove allows maximum strength connections.

Les nouvelles gammes de profilés avec les cotes de trame de 40 mm et 50 mm complètent les profilés avec cote de trame de 45 mm de manière cohérente. Le système modulaire étendu de profilés de Bosch Rexroth AG couvre maintenant la totalité des cotes de trame de profilés courantes dans le monde entier.

Les profilés d'étayage L à rainure de 10 mm (cote de trame de 40 mm, 45 mm et 50 mm, par ex. 50x50L) offrent, grâce à leur construction optimisée par ordinateur, une très grande résistance avec une exploitation de matériau réduite. Vous avez ainsi à votre disposition une solution économique et stable lorsque vous désirez par exemple construire des tables, des dispositifs de protection ou des bâtis.

Pour les applications avec charges importantes, nous recommandons des profilés avec la rainure de 10 mm particulièrement stable par ex. pour les tables de travail, les installations, les bâtis de machine, les chariots de transport, les cabines de protection et les systèmes de manipulation qui sont lourds. Du fait de la construction très puissante, cette rainure permet d'effectuer des jonctions de résistance extrême.

Profile · Profiles · Profilés

Nut, Rastermaß, Zentralbohrung
Groove, modular dimension, central bore
Rainure, cote de trame, alésage central

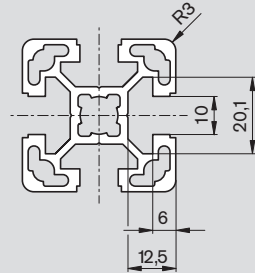
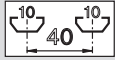

00110722

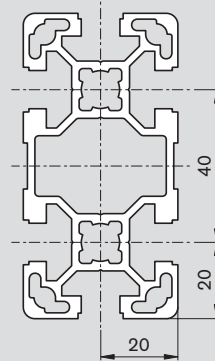

00110723

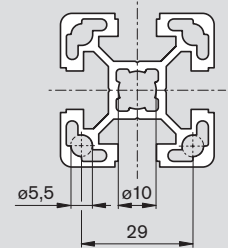

00110724

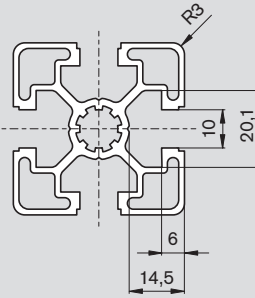
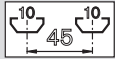

00110728

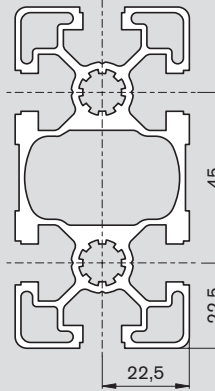

00110729

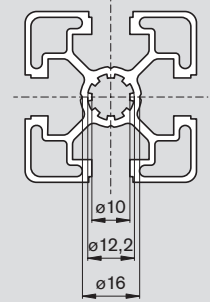

00110730

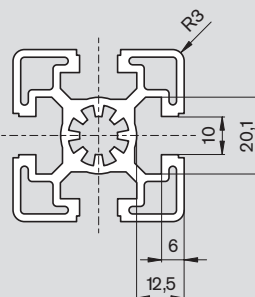

00110725

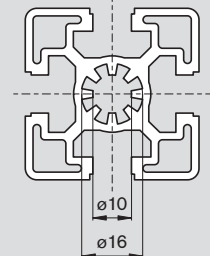

00110727

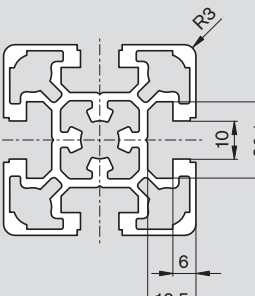
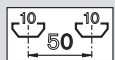

00110731

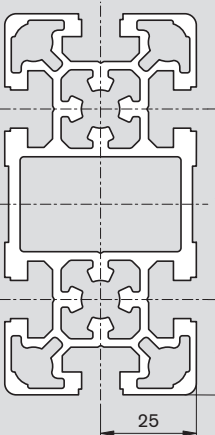

00110732

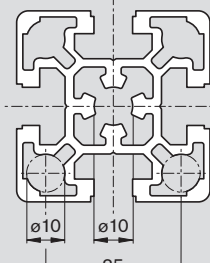

00110733

Endenbearbeitung
End finishing
Usinage des extrémités

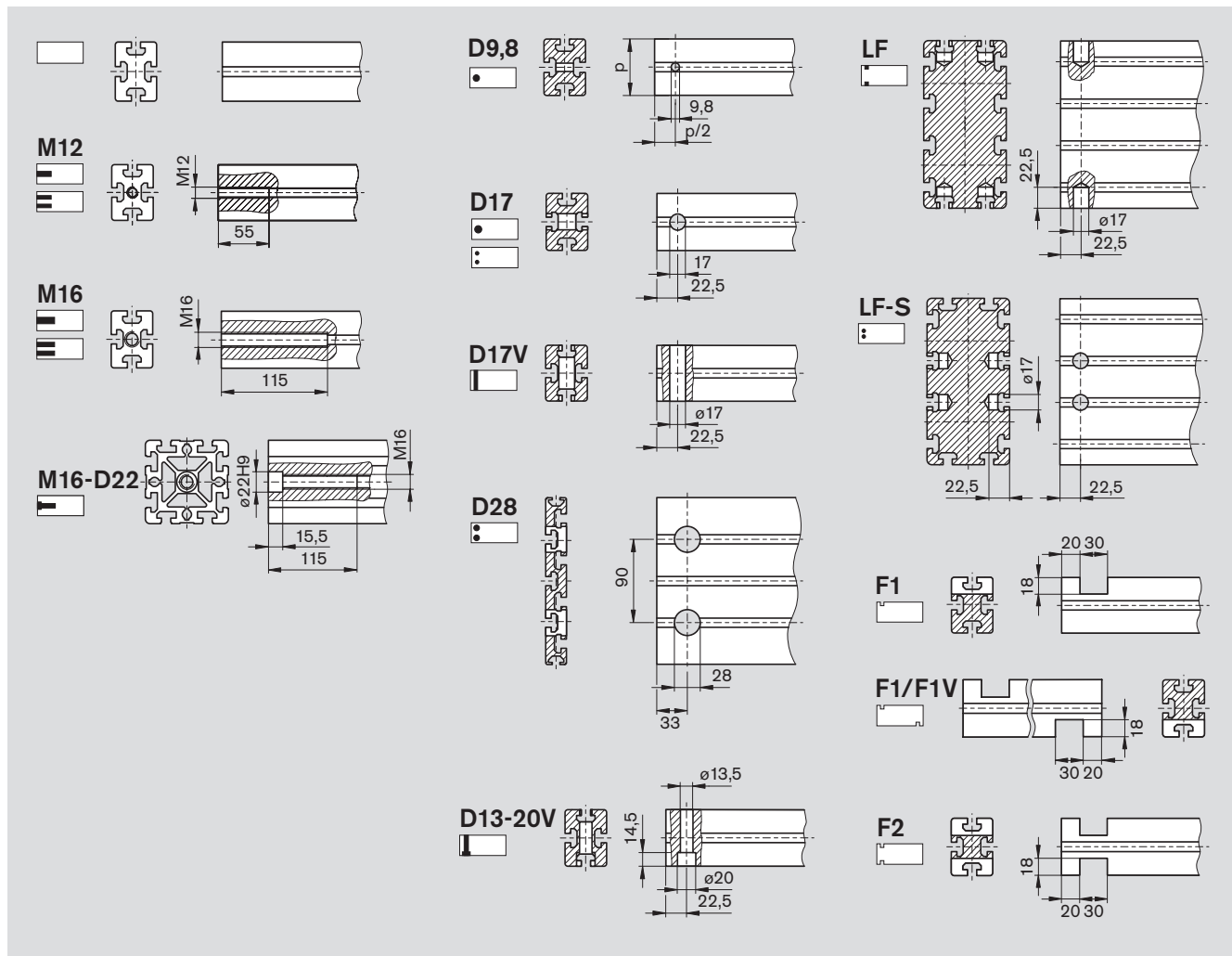

Weitere Bearbeitungen werden von Ihrem Vertriebspartner realisiert.
 Other finishes can be carried out by your authorized dealer.
 Votre partenaire de distribution se chargera de la réalisation de la suite des étapes de la mise en œuvre.

Profile · Profiles · Profilés

45x90
45x180
45x270

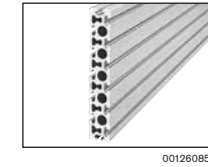
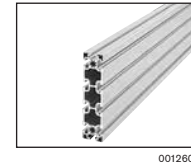
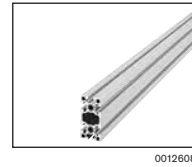

00126083

00126084

00126085



45x90

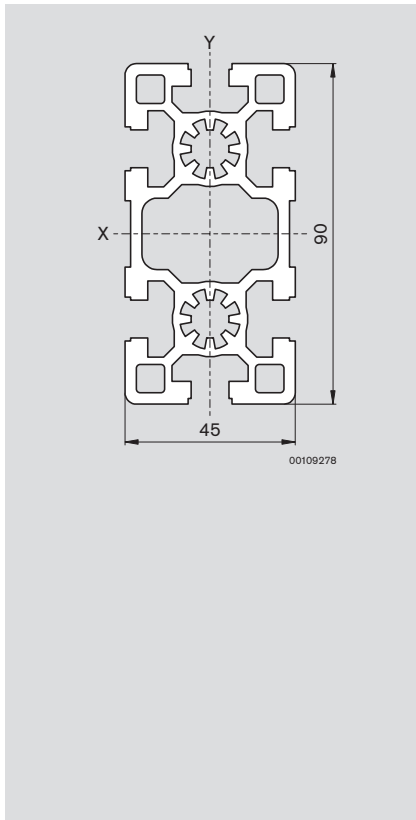

45x180

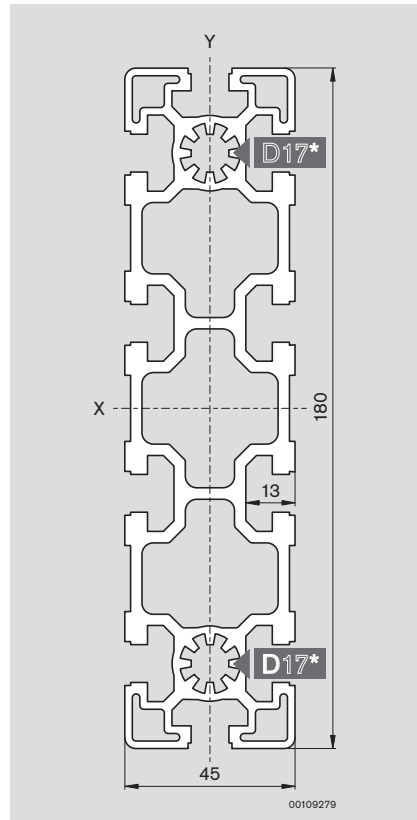

45x270

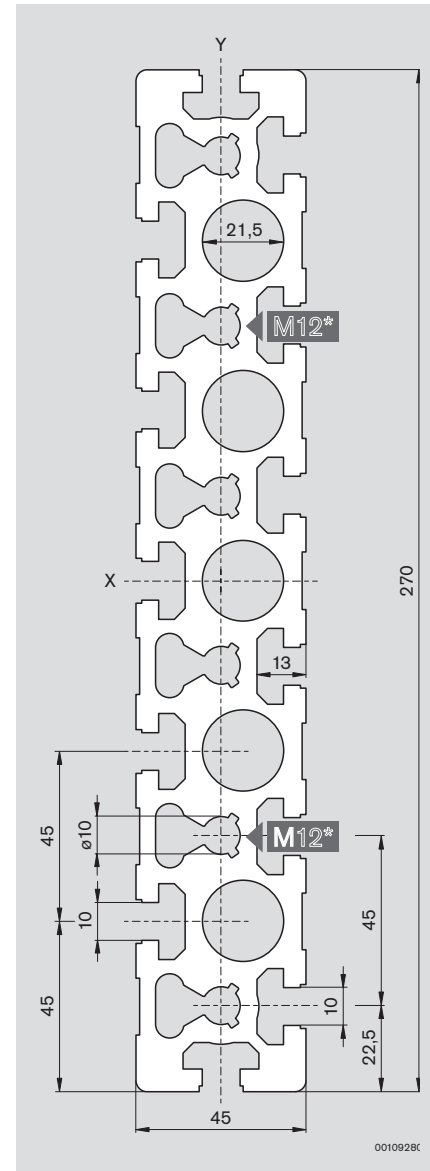

2

45x90

LE 1 x L = ... mm	
	3 842 990 300 / ...
M12	3 842 990 301 / ...
M12	3 842 990 302 / ...
M12	3 842 990 323 / ...
M12	3 842 990 305 / ...
M16	3 842 990 303 / ...
M16	3 842 990 304 / ...
M16	3 842 990 325 / ...
M16	3 842 990 307 / ...
D17V	3 842 990 331 / ...
D17V	3 842 990 309 / ...
D17	3 842 990 311 / ...
D17	3 842 990 329 / ...
D17	3 842 990 313 / ...
50 mm ≤ L ≤ 5600 mm	
LE 12 x L = 5600 mm	
	3 842 509 186

45x180

LE 1 x L = ... mm	
	3 842 990 335 / ...
M12	3 842 990 336 / ...
M12	3 842 990 339 / ...
D17	3 842 990 342 / ...
D17V	3 842 990 344 / ...
50 mm ≤ L ≤ 5600 mm	
LE 6 x L = 5600 mm	
	3 842 509 187

45x270

LE 1 x L = ... mm	
	3 842 992 927 / ...
M12	3 842 992 928 / ...
50 mm ≤ L ≤ 5600 mm	
LE 2 x L = 5600 mm	
	3 842 520 025



2-10,
2-11
16-2



2-27



2-28



2-59



2-64